

Data Sheet



Article number: 25220267002

Description: ICME Single-phase motor MD100 B2 2,2KW
2 - 2800 rpm 1x230 Volt 50Hz B3/B5 with starting & running capacitor

Measures

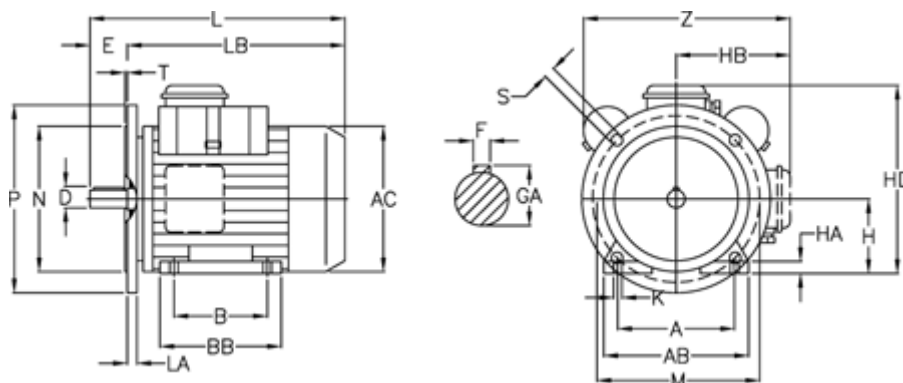

A = 160	H = 100	N = 180
AB = 200	HA = 14	P = 250
AC = 195	HB = 140	S = 14
B = 140	K = 12	T = 4
D = 28	L = 403	Z = 260
E = 60	LA = 14	
F = 8	LB = 343	
GA = 31	M = 215	